

Varactor-Tuned Oscillators

Technical Data

Features

- **600 MHz to 10.5 GHz Coverage**
- **Fast Tuning**
- **+7 to +13 dBm Output Power**
- **±1.5 dB Output Flatness**
- **Hermetic Thin-film Construction**

Description

HP VTO-8000 Series oscillators use a silicon transistor chip as a negative resistance oscillator. The oscillation frequency is determined by a silicon abrupt varactor diode acting as a voltage-variable capacitor in a thin-film micro-stripline resonator. This provides extremely fast tuning speed, limited primarily by the internal impedance of the user-supplied voltage driver. Fast settling is another feature of the HP VTO-8000 Series oscillators. Typical settling times for the VTO-8090 are <200 kHz within one microsecond while the VTO-8950 settles to <2 MHz within two microseconds referenced to ten milliseconds. The VTO-8850 combines a bipolar transistor oscillator with a GaAs FET buffer stage. This GaAs FET buffer isolates the oscillator from

variations in load impedance for low frequency pulling, allows the oscillator to run lightly-loaded for low phase noise content and provides +10 dBm of minimum output power over the full tuning range. The VTO-8000 Series varactor-tuned oscillators are packaged in TO-8 transistor cans for simple installation in a conventional 50-ohm micro-stripline PC board. They are ideal for most compact, lightweight commercial and military equipment designs. Test fixturing is also available for lab bench test applications. See the "Test Fixtures for TO-8 Packages" section for additional information and outlines.

Applications

Frequency agile systems, such as digitally controlled receivers and active jamming transmitters often use externally linearized varactor-tuned oscillators. HP oscillators are monotonic making external linearization easy using analog (opamp) or digital (EPROM) linearizing techniques. The HP VTO Series has been designed with a tuning input bypass capacitance which is sufficient to provide the necessary RF filtering action yet as low

VTO-8000 Series

Pin Configuration TO-8V

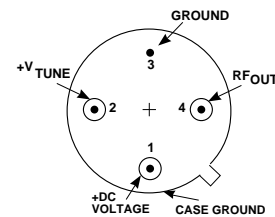

as possible to maximize $\Delta V/\Delta T$ characteristics for excellent tuning speeds. Used in a phase locked loop PLL circuit, a VTO provides a receiver LO with stability equivalent to the reference oscillator (usually crystal controlled), yet variable in discrete steps or continuously depending on the PLL configuration.

Another important aspect of VTOs used in an LO application is their power vs. frequency flatness (± 1.5 dB). This assures that once a receiver mixer is biased for best dynamic range the local oscillator drive will remain constant throughout the tuning range without complex leveling circuitry.

Electrical and Performance Specifications

Guaranteed Specifications @ 25°C Case Temperature (0° to +65°C Operating Temperature)

Part Number	VTO-8060	VTO-8080	VTO-8090	VTO-8150	VTO-8200
Frequency Range, Min.	600–1000 MHz	800–1400 MHz	900–1600 MHz	1500–2500 MHz	2000–3000 MHz
Power Output into 50-ohm Load, Min.	20 mW/+13 dBm	20 mW/+13 dBm	20 mW/+13 dBm	10 mW/+10 dBm	10 mW/+10 dBm
Power Output Variation @ 25°C, Max.	±1.5 dB	±1.5 dB	±1.5 dB	±1.5 dB	±1.5 dB
Operating Case Temperature Range	0° to +65°C	0° to +65°C	0° to +65°C	0° to +65°C	0° to +65°C
Frequency Drift Over Operating Temperature, Typ.	8 MHz	10 MHz	10 MHz	18 MHz	30 MHz
Pulling Figure (12 dB Return Loss), Typ.	25 MHz	25 MHz	25 MHz	35 MHz	35 MHz
Pushing Figure, +15 VDC Supply, Typ.	5 MHz/V	6 MHz/V	6 MHz/V	6 MHz/V	6 MHz/V
Harmonics, Below Carrier, Typ.	-15 dB	-15 dB	-15 dB	-15 dB	-18 dB
Spurious Output Below Carrier, Min.	-60 dB	-60 dB	-60 dB	-60 dB	-60 dB
Tuning Voltage					
Low Frequency	3±1 VDC	2±1.5 VDC	2±1 VDC	2.5±1 VDC	2+2/-1 VDC
High Frequency	40±8 VDC	35±10 VDC	48+8/-10 VDC	47±8 VDC	20±4 VDC
Maximum Tuning Voltage	+60 VDC	+60 VDC	+60 VDC	+60 VDC	+45 VDC
Tuning Port Capacitance, Nom.	180 pF	180 pF	180 pF	90 pF	45 pF
Phase Noise, Single Sideband,					
1 Hz Bandwidth, Typ.					
50 kHz From Carrier	-110 dBc/Hz	-100 dBc/Hz	-100 dBc/Hz	-95 dBc/Hz	-95 dBc/Hz
100 kHz From Carrier	-117 dBc/Hz	-107 dBc/Hz	-107 dBc/Hz	-102 dBc/Hz	-102 dBc/Hz
Input Power ±1% Regulation					
Voltage, Nom.	+15 VDC	+15 VDC	+15 VDC	+15 VDC	+15 VDC
Current, Max.	50 mA	50 mA	50 mA	50 mA	50 mA
Case Style	TO-8V	TO-8V	TO-8V	TO-8V	TO-8V

Part Number	VTO-8240	VTO-8360	VTO-8430	VTO-8580
Frequency Range, Min.	2400–3700 MHz	3600–4300 MHz	4300–5800 MHz	5800–6600 MHz
Power Output Into 50-ohm Load, Min.	10 mW/+10 dBm	10 mW/+10 dBm	10 mW/+10 dBm	5 mW/+7 dBm
Power Output Variation @25°C., Max.	±1.5 dB	±1.5 dB	±1.5 dB	±1.5 dB
Operating Case Temperature Range	0° to +65°C	0° to +65°C	0° to +65°C	0° to +65°C
Frequency Drift Over Operating Temperature, Typ.	30 MHz	35 MHz	60 MHz	70 MHz
Pulling Figure (12 dB Return Loss), Typ.	35 MHz	40 MHz	50 MHz	70 MHz
Pushing Figure, +15 VDC Supply, Typ.	6 MHz/V	6 MHz/V	6 MHz/V	8 MHz/V
Harmonics, Below Carrier, Typ.	-18 dB	-25 dB	-25 dB	-25 dB
Spurious Output Below Carrier, Min.	-60 dB	-60 dB	-60 dB	-60 dB
Tuning Voltage				
Low Frequency	2+2/-1 VDC	8±2 VDC	1.0 VDC Min	5±2.5 VDC
High Frequency	30±8 VDC	24±4 VDC	20.0 VDC Max.	24+3/-5 VDC
Maximum Tuning Voltage	+45 VDC	+30 VDC	+30 VDC	+30 VDC
Tuning Port Capacitance, Nom.	45 pF	45 pF	45 pF	45 pF
Phase Noise, Single Sideband,				
1 Hz Bandwidth, Typ.				
50 kHz From Carrier	-95 dBc/Hz	-100 dBc/Hz	-90 dBc/Hz	-85 dBc/Hz
100 kHz From Carrier	-102 dBc/Hz	-108 dBc/Hz	-97 dBc/Hz	-92 dBc/Hz
Input Power ±1% Regulation				
Voltage, Nom.	+15 VDC	+15 VDC	+15 VDC	+15 VDC
Current, Max.	50 mA	50 mA	50 mA	50 mA
Case Style	TO-8V	TO-8V	TO-8V	TO-8V

Electrical and Performance Specifications

Guaranteed Specifications @ 25°C Case Temperature (0° to +65°C Operating Temperature)

Part Number	VTO-8650	VTO-8810	VTO-8850	VTO-8950
Frequency Range, Min.	6500-8600 MHz	8100-9100 MHz	8500-9600 MHz	9500-10500 MHz
Power Output Into 50-ohm load, Min.	10 mW/+10 dBm	10 mW/+10 dBm	10 mW/+10 dBm	10 mW/+10 dBm
Power Output Variation @ 25°C., Max.	±1.5 dB	±1.5 dB	±1.5 dB	±1.5 dB
Operating Case Temperature Range	0° to +65°C	0° to +65°C	0° to +65°C	0° to +65°C
Frequency Drift Over Operating Temperature, Typ.	100 MHz	110 MHz	110 MHz	160 MHz
Pulling Figure (12 dB Return Loss), Typ.	15 MHz	8 MHz	10 MHz	20 MHz
Pushing Figure, +15 VDC Supply, Typ.	10 MHz/V	12 MHz/V	15 MHz/V	10 MHz/V
Harmonics, Below Carrier, Typ.	-20 dB	-15 dB	-25 dB	-20 dB
Spurious Output Below Carrier, Min.	-60 dB	-60 dB	-60 dB	-60 dB
Tuning Voltage				
Low Frequency	2±1 VDC	2 VDC Min.	5±2 VDC	4±1 VDC
High Frequency	20±5 VDC	16 VDC Max.	13±5 VDC	10 VDC Max.
Maximum Tuning Voltage	30 VDC	+30 VDC	+30 VDC	+15 VDC
Tuning Port Capacitance, Nom.	26 pF	26 pF	26 pF	26 pF
Phase Noise, Single Sideband, 1 Hz Bandwidth, Typ.				
50 kHz From Carrier	-80 dBc/Hz	-80 dBc/Hz	-82 dBc/Hz	-73 dBc/Hz
100 kHz From Carrier	-88 dBc/Hz	-88 dBc/Hz	-90 dBc/Hz	-80 dBc/Hz
Input Power ±1% Regulation				
Voltage, Nom.	+15 VDC	+15 VDC	+15 VDC	+15 VDC
Current, Max.	50 mA	100 mA	100 mA	100 mA
Case Style	TO-8V	TO-8V	TO-8V	TO-8V

Schematic

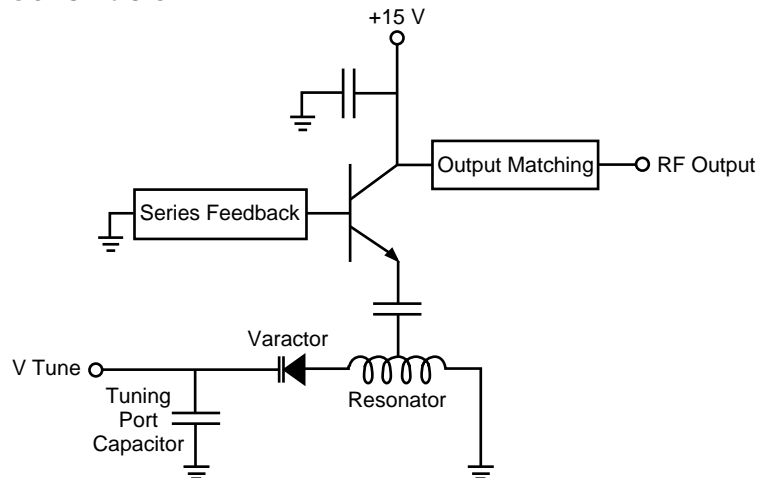

Typical Performance @ 25°C Case Temperature

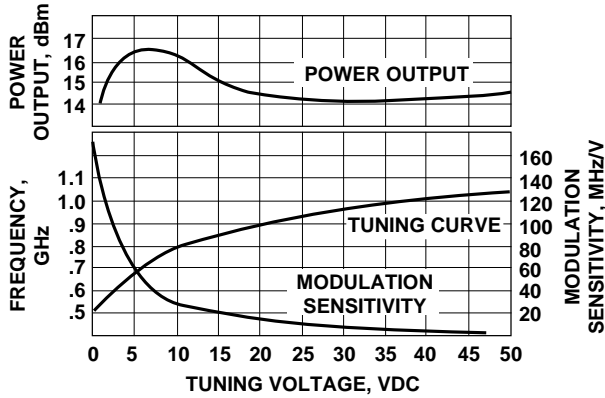

Figure 1. VTO-8060 Power Output, Frequency and Modulation Sensitivity vs. Tuning Voltage.

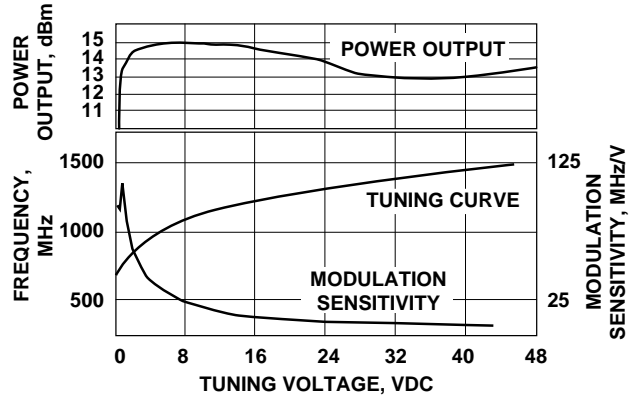

Figure 2. VTO-8080 Power Output, Frequency and Modulation Sensitivity vs. Tuning Voltage.

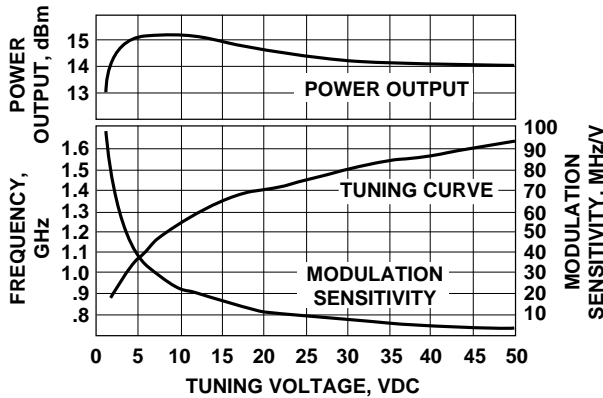

Figure 3. VTO-8090 Power Output, Frequency and Modulation Sensitivity vs. Tuning Voltage.

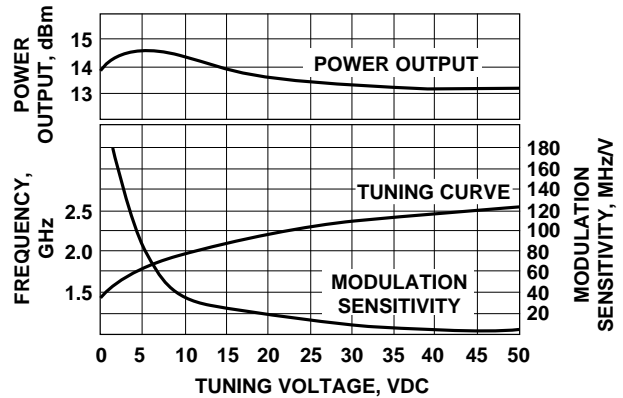

Figure 4. VTO-8150 Power Output, Frequency and Modulation Sensitivity vs. Tuning Voltage.

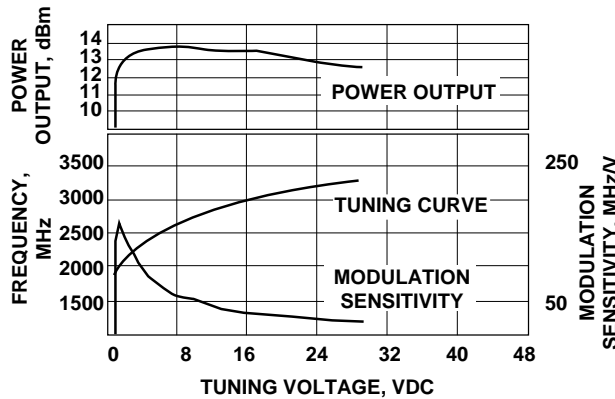

Figure 5. VTO-8200 Power Output, Frequency and Modulation Sensitivity vs. Tuning Voltage.

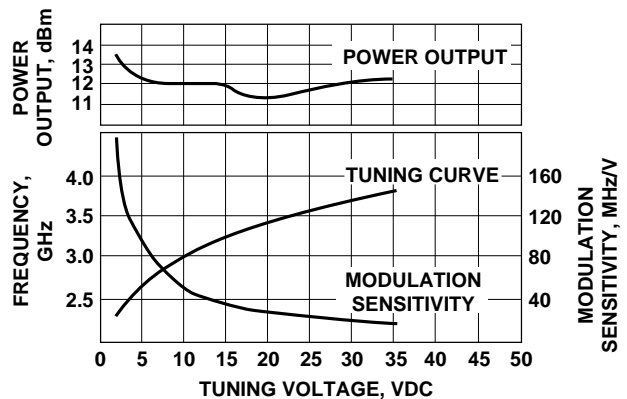

Figure 6. VTO-8240 Power Output, Frequency and Modulation Sensitivity vs. Tuning Voltage.

Typical Performance (Continued)

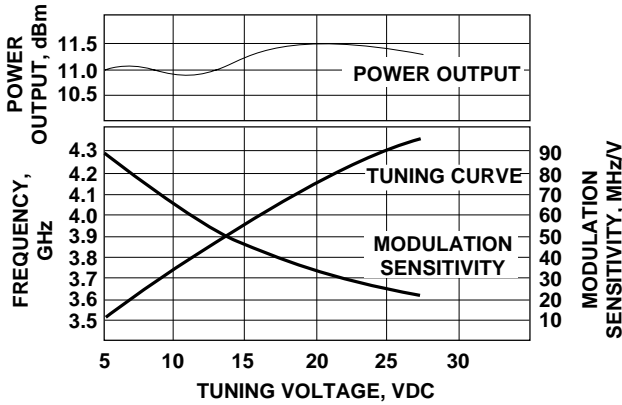

Figure 7. VTO-8360 Power Output, Frequency and Modulation Sensitivity vs. Tuning Voltage.

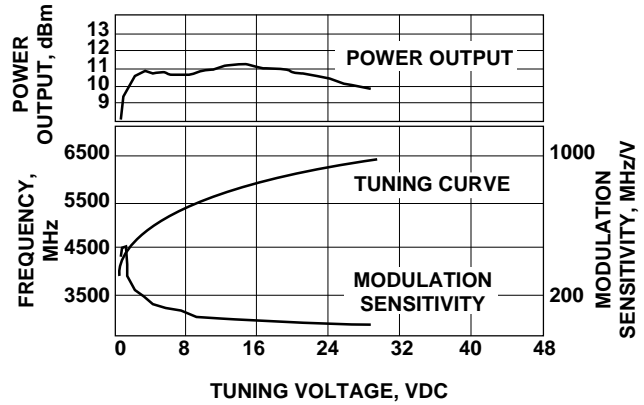

Figure 8. VTO-8430 Power Output, Frequency and Modulation Sensitivity vs. Tuning Voltage.

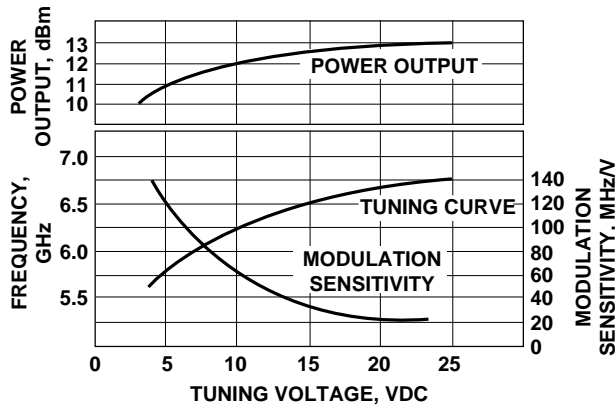

Figure 9. VTO-8580 Power Output, Frequency and Modulation Sensitivity vs. Tuning Voltage.

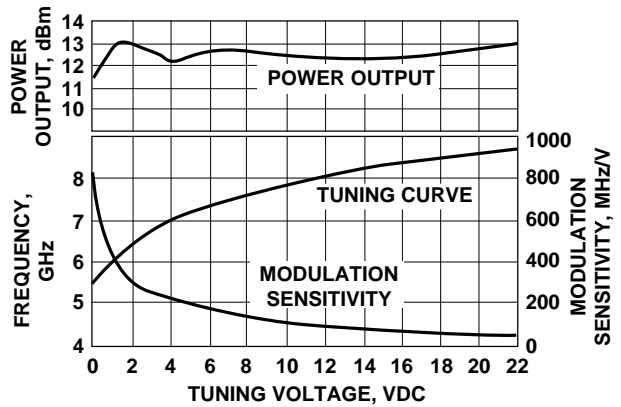

Figure 10. VTO-8650 Power Output, Frequency and Modulation Sensitivity vs. Tuning Voltage.

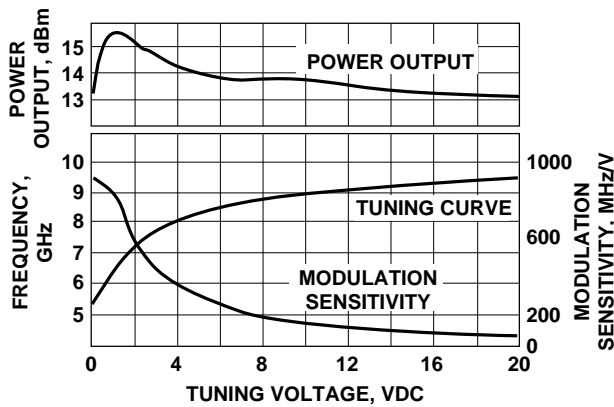

Figure 11. VTO-8810 Power Output, Frequency and Modulation Sensitivity vs. Tuning Voltage.

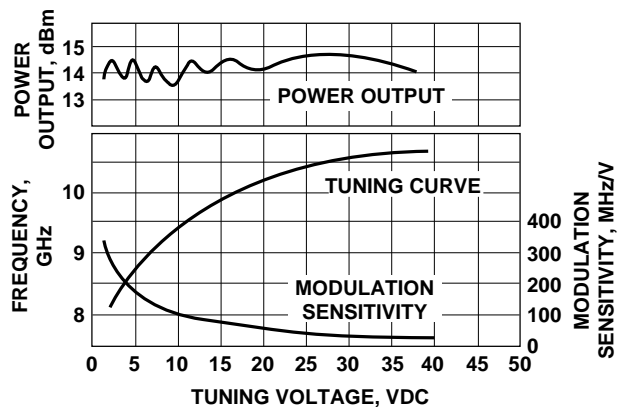

Figure 12. VTO-8850 Power Output, Frequency and Modulation Sensitivity vs. Tuning Voltage.

Test Fixtures for TO-8 Packages (TF 801/802) Oscillators (VTO)

Features

- DC to 11 GHz Frequency Range
- Connectorized Tuning Port and RF Output
- Easy to Test Package
- Repeatable Performance

Applications

- Engineering Characterization
- Incoming Inspection
- System Prototype
- Demonstration of Device Performance

Description

To facilitate testing and prototyping of products in the TO-8V package, a series of test fixtures is available. Designated the HP TF Series test fixtures, they feature rugged construction for precise, repeatable measurements.

The TF Series test fixtures come supplied with mounting hardware to ensure excellent ground contact between the oscillator package and test fixture. This assures excellent contact between package pins and test fixture connector pins for reliable testing.

The device under test is aligned according to Figure 15, and pushed fully down onto the fixture. The steel mounting ring

clamp is placed over the device under test and secured by machine screws prior to testing. Orientation of pins can be verified by comparison with part (c) of Figure 15. It is recommended that both machine screws be used to fasten the ring clamp. Screws should be tightened down snugly with a jewelers type screwdriver.

For different connector options check the table in Figure 15 to identify the correct part numbers.

It should be noted that some output power variation may be seen, from unit data, at frequencies above 8 GHz. This is due to small differences in lengths of test fixture RF output connector pins.

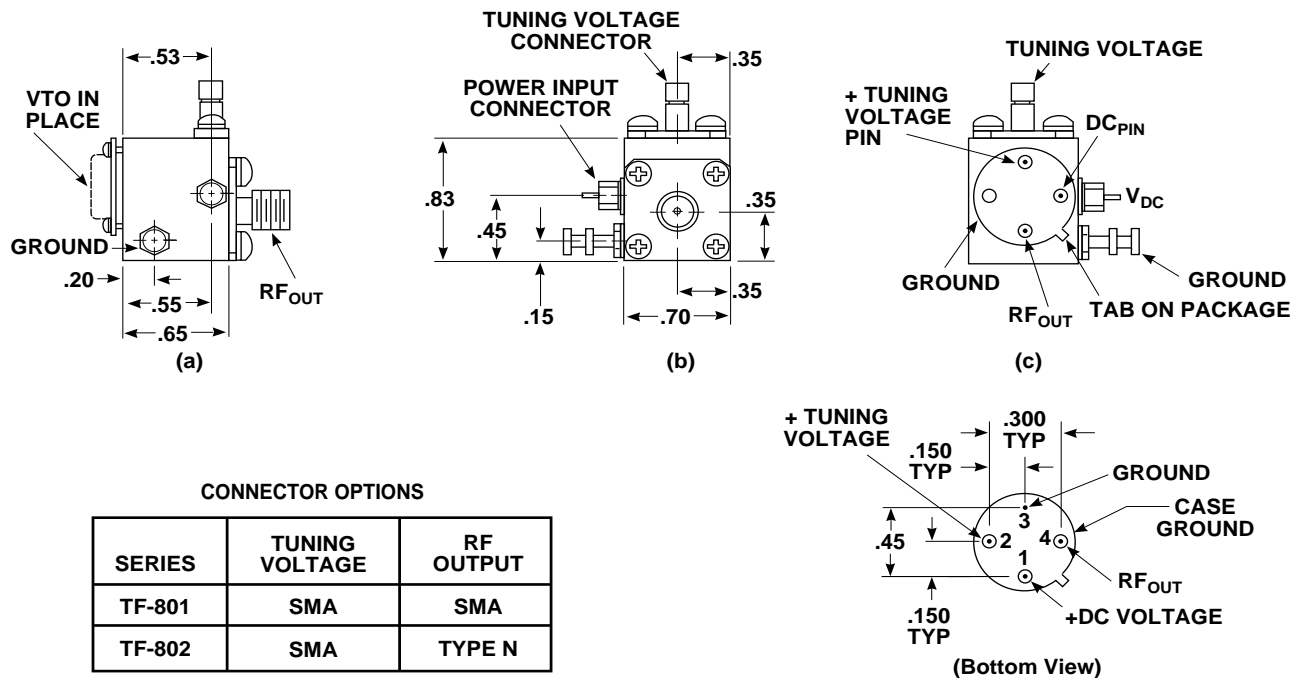

Figure 15. TO-8 Test Fixture.



For technical assistance or the location of
your nearest Hewlett-Packard sales office,
distributor or representative call:

Americas/Canada: 1-800-235-0312 or
408-654-8675

Far East/Australasia: (65) 290-6305

Japan: (81 3) 3331-6111

Europe: Call your local HP sales office
listed in your telephone directory. Ask for
a Components representative.

Data subject to change.
Copyright © 1996 Hewlett-Packard Co.

Obsoletes 5963-3264E
Printed in U.S.A. 5964-9815E (3/96)